

UL 924 UPS Product Line



20-30 kVA 208V UL 924 UPS

Features

- Simplifies UL 924 compliance and testing with a central UPS system. No need for individual fixture testing and maintenance.
- Microprocessor-controlled ABM® technology significantly increases battery service life
- An Eaton factory limited warranty, technical support and optional service plans provide investment protection and peace of mind

The Eaton UL 924 UPS line meets the needs of businesses trying to simplify UL 924 compliance and operation in one office, or across multiple corporate locations. The line features a unified interface across all capacities, so smaller facilities needing only 8 kVA of emergency lighting backup will operate in the same fashion as a facility with a 30 kVA unit. Company procedures across locations can be easily standardized.

Eaton's UL 924 product line includes both the UPS system and all required line and match battery cabinets required to achieve the minimum 90 minutes of run-time. The Eaton UL 924 UPS line combines the industry's highest capacity and smallest footprint, making it the most cost-effective solution to comply with UL 924

Eaton's UPS systems are backed by an extensive service network of over 240 field technicians, providing prompt service, full maintenance and stocked replacement parts not available from other vendors or providers.

Remember only a completely tested UPS and 90 minute battery supplied from one manufacturer or supplier can carry the UL 924 listing. In complying with the code, always verify the specific UL 924 listing is present for all supplied components as a complete system

Product Snapshot

Power Rating:	8 to 30 kVA
Topology:	Double-conversion online UPS
Battery Runtime:	minimum 90 minutes at full load
Frequency:	50/60 Hz auto-sensing



Service

Proven warranty and support services

Customers consistently rank Eaton services number one in quality. Eaton's comprehensive, world-class service solutions are designed to improve costs, uptime, reliability, power quality and safety. And with 240 field service technicians in North America and 1,200 international authorized service providers, Eaton has more service personnel than any other UPS manufacturer.

The standard factory warranty covers:

- System warranty: One year parts / 90 days labor
- Battery warranty: Two years parts / 90 days labor

Extensive service options for enhanced reliability

For support beyond the warranty period, Eaton offers enhanced service options including onsite startup, corrective and preventive maintenance, battery solutions, training, remote monitoring and factory spare parts and upgrades. Customizable three-phase UPS services packages allow customers to select the plan that provides the right combination of system uptime, convenience and value.

Connectivity & manageability

Enhanced communication capabilities

UL 924 UPSs are equipped with a variety of standard communications features for network connectivity and remote management applications, including:

- RS-232 serial port
- Two X-Slot® communication bays
- Relay output contacts
- Two programmable signal inputs

Centralized control and visibility

Intelligent Power Manager software for monitoring

- Monitor and manage multiple power devices across the network from any PC with an Internet browser
- Compatible with VMware's vCenter™ Server
 - View your power and network devices from the same vCenter dashboard
 - During a power event, the software triggers vMotion™ to transparently move virtual machines to an available server on the network for zero downtime

Intelligent Power Protector software for shutdown

- Gracefully shuts down computers and virtual machines/ servers (powered by an Eaton UPS) during a power outage that lasts longer than the available battery runtime

Download from the Power Quality website:

www.eaton.com/intelligentpower

eNotify Remote Monitoring

Eaton's eNotify Remote Monitoring Service provides 24x7 real-time monitoring of the UPS and battery systems and alerts both service technicians and the customer when a problem is detected. Proactive monitoring enables technical experts to respond immediately to more than 40 alarm conditions and, in many cases, resolve issues remotely with minimal or no downtime. Additional eNotify benefits include:

- One-way outbound status and event e-mails for security and reliability
- Fast diagnosis and notification of critical alarms
- Monthly customer reports including power event logs and overall UPS and battery health summaries

Performance Criteria for UL 924 Compliance

Feature	UL 924 Code Section	Requirement
90 minutes of backup	70.1.6	All Eaton UL 924 UPS solutions are configured with 90 minutes of backup time, which is required by the UL 924 standard.
Manually Operated Test Switch	29.1	The UL 924 series all feature a manually operated test switch for conducting the mandated standard equipment tests.
Protected Test Switch	29.3 & 8.7.1-8.7.4	In accordance with the standard, the manually operated test switch is protected from accidental operation and protected from non-authorized users.

Dimensional Drawings

Front View

Side View

Bottom View

**8 kVA
(277V)
10 kVA**

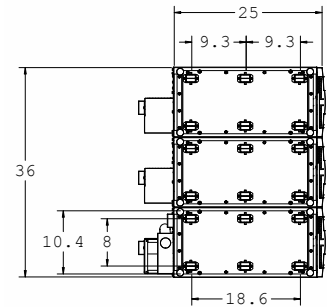
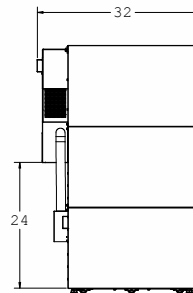
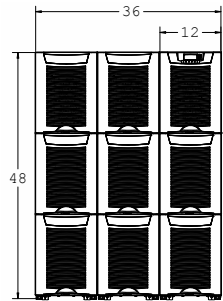

15 kVA

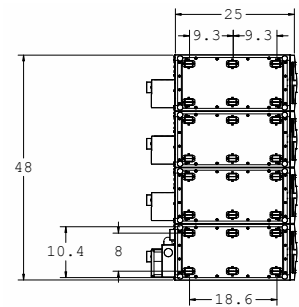
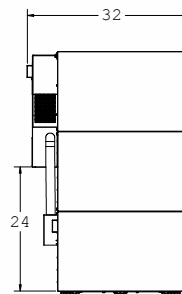
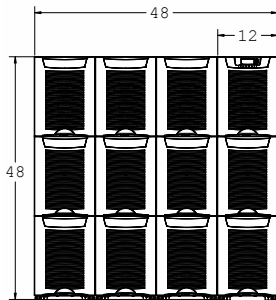

20 - 30 kVA

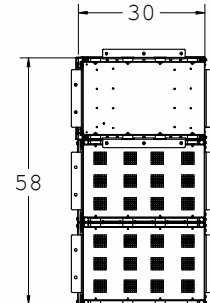
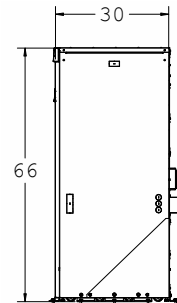
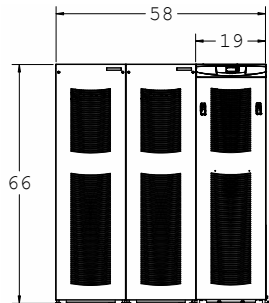

**20 - 30 kVA
(480V)**

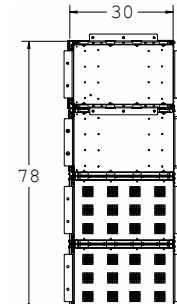
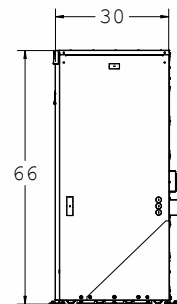
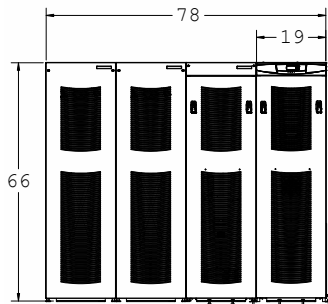

TECHNICAL SPECIFICATIONS

Eaton UL 924 UPS Part Number	BH-8KEL277-100	BH-10KEL277-100	BH-10KEL2083P-100	BH-15KEL2083P-100	BH-20KEL208-100	BH-20KEL2083P-100*	BH-30KEL208-100	BH-30KEL2083P-100*
Ratings (kVA/kW)	8 kVA / 7.2 kW	10 kVA / 9 kW		15 kVA / 13 kW	20 kVA / 18 kW		30 kVA / 27 kW	
Topology	Double-conversion Online UPS							
Operating Frequency	50/60 Hz (45 to 65 Hz)							
Input Power Factor	>0.99 typical, >0.96 frequency converter							
Input Current Distortion	5% THD							
Output Voltage	277 VAC	277 VAC	208 VAC	208 VAC	208 VAC	480/277 VAC	208 VAC	480/277 VAC
Input Voltage	277 VAC	277 VAC	208 VAC 3P	208 VAC 3P	208 VAC 3P	480 VAC 3P	208 VAC 3P	480 VAC 3P
Output Voltage Regulation	±1% Static; ±5% dynamic at 100% resistive load change, <1 ms response time							
Extended Battery Module Part Number	BH-EBM96EL-600	BH-EBM96EL-600		BH-EBM96EL-600	BH-EBC72EL-600			
# of Extended Battery Modules for 90 minutes	2	2		3	2			
Actual Runtime (min)	139	120	124	113	114		108	
Overload	150% for 5 sec / 125% for 1 min (online), 110% for 10 min (Normal Operation)							
Communication Ports	(1) RS-232, (1) Relay Contact, (1) REPO, (2) Environmental Input							
Communication Slot	(2) X-Slot communication bays							
Operating Temperature	10°C to +40°C, +45°C with 7.5% derating; Batteries recommended max. +25°C							
Storage Temperature	-15°C to +25°C							
Relative Humidity	0-95%, non-condensing							
Audible Noise	<53 dBA @ 1 meter, typical							
Altitude	<1000m at +40°C, <3000m at +25°C							
Safety Certifications	UL 924, UL 1778**, NOM-0190SCFI-1993, CSA C22.2, IEC 60950, IEC 62040-1-1, No. 107.3;EN 5502 Class A (CISPR22 Class A)							
EMC Compliance	IEC 62040-2, FCC Part 15, ICES-003, VCCI							
Quality	ISO 9001: 2000 and ISO 14001:1996							
Markings	UL, cUL, CSA, CE and NOM-NYCE							
Dimensions H x W x D (in)***	48 x 36 x 32			48 x 48 x 32	66 x 58 x 30	66 x 78 x 30	66 x 58 x 30	66 x 78 x 30
Weight (lb)***	2,010			2,720	5,280	7,510	5,280	7,510

* Options Cabinet BH-KBT004-200 required

** 277V models are not UL1778.

*** Dimensions and weights include all battery cabinets and batteries.

UNITED STATES
8609 Six Forks Road
Raleigh, NC 27615 U.S.A.
Toll Free: 1.800.356.5794

www.eaton.com/powerquality



Eaton, PowerChain Management, ABM, ConnectUPS, LanSafe, PowerVision, Powerware Hot Sync, and X-Slot are trade names, trademarks and/or service marks of Eaton Corporation or its subsidiaries and affiliates. All other trademarks are property of their respective owners.

©2010 Eaton Corporation
All Rights Reserved
Printed in USA
UL924FXA
October 2010